

SMITH-ROOT, INC.
14014 NE Salmon Creek Avenue
Vancouver, WA 98686 USA

INSTRUCTION MANUAL
MODEL 903-D
ELECTRONIC FISH COUNTER

TABLE OF CONTENTS:	PAGE
General Description.....	1
Principle of Operation.....	1
Advanced Features.....	1
Water Conditions.....	1
Counting Tunnels.....	2
Power Requirements.....	2
Mechanical Construction.....	2
Output Connectors & Plugs.....	2
Description of Controls & Indicators.....	3
Power Switch.....	3
Low Battery Indicator.....	3
Count Reset.....	3
Sensitivity Control.....	3
Balance Meter & Control.....	3
Upstream & Downstream Registers.....	3
Plugs & Connectors.....	3
Alignment Procedure.....	4
Specifications.....	4
Warranty.....	5
Schematic.....	6

MODEL 903-D ELECTRONIC FISH COUNTER

General Description:

The 903-D Electronic Fish Counting System provides a state-of-the-art counting system designed to simultaneously monitor both upstream and downstream fish movements. Completed fish passages are tallied on a pair of 6 digit LCD front panel displays. The Model 903-D is designed for simplicity of operation and ease of installation. This unit is provided with a rugged weather-proof case for protection from the elements.

Principle of Operation:

Operation of the 903-D Counter is based on the "Balanced Conductivity Bridge Principle" using water in a fish tunnel as two elements of a four element Balanced Bridge. Passage of a fish through the tunnel causes corresponding changes in tunnel conductance. These conductance changes are used by the 903-D to sense the presence and directional movements of fish in the tunnel.

Advanced Features:

The Counter employs numerous advanced features providing such functions as automatic balance which compensates for slow changes in water conductivity, ambient temperature, and marine growth. This makes possible truly "set it and forget it" unattended counting operations. Other new features of the 903-D include the ability to output fish directional information for a data logger or computer monitoring. The counts of completed fish passages are displayed on liquid crystal displays, which provide easy readability even in direct sunlight. The count is retained by internal batteries if power to the fish counter is lost. Also included is a wide-range sensitivity control which provides the ability to set the size of the smallest fish that will be counted.

Water Conditions:

The Model 903-D is designed to work in fresh water within a conductivity range of 10 to 500 micromhos. The sensing tunnel must be completely submerged in the water where the fish will be passing. The water flow through the tunnel should be swift enough that the fish will not mill around and will complete their passage through the tunnel. The water also should be relatively free of air bubbles and debris. Water turbidity is not usually a factor to count accuracy, however it may be useful to observe fish behavior within the sensing tunnel. With the proper selection of tube diameter to fish size and with sufficient water flow, count accuracy is better than 98 %.

Model 903-D, Cont.

Counting Tunnels:

The 903-D Fish Counter can be used with a wide variety of tunnel sizes and shapes. All counting tunnels are interchangeable and are supplied with 25 feet of cable. Additional cable lengths are available. Standard round tunnels are fabricated from PVC, ABS, or fiberglass and are available in diameters ranging from 1 to 24 inches. Various other square, round and rectangular shapes are custom fabricated to meet special requirements as needed. Please consult the factory for further details.

Power Requirements:

The Model 903-D is versatile. It can be powered either from 115 VAC, 60 Hz or from external 12 volts DC or from an optional internal 12 volt rechargeable battery. The battery will provide 15 to 30 days of operation depending on water conductivity. When the counter is powered from 115 VAC, the optional battery is kept fully charged.

An indicator automatically flashes when the battery condition is low. Battery recharge time is about 12 hours.

Mechanical Construction:

Designed for outdoor environments, the 903-D enclosure is rain-tight, and features rugged, 0.06" thick all welded aluminum construction. The top cover is provided with a see-thru window which allows observation of count read-outs while still maintaining water-tight integrity. The case measures 12.6" wide X 6.0" deep X 4.5 inches high. It is painted with a durable epoxy based paint.

Output Connectors and Plugs:

Outputs provided from the 903-D Counter may be used to drive remote counters or the model FDL-903 Field Data Logger. The 903-D also features quick-twist positive locking type polarized connectors to insure easy and positive connections.

Model 903-D, Cont.

DESCRIPTION OF CONTROLS AND INDICATORS:

Power Switch:

Controls the DC power to operate the fish counter electronics. The DC may be supplied from an internal battery, from an external 12 volt DC source, or from the internal AC powered DC supply. It does not control the AC power to the battery charger circuit.

Low Battery Indicator:

The Low Battery LED indicator flashes when the optional internal battery needs to be recharged or when the external 12 volt source is too low. There is about 24 hours of operation left on the internal battery once the indicator begins flashing.

Count Reset:

The Count Reset pushbutton resets both the Upstream and Downstream LCD displays to zero.

Sensitivity Control

The front panel sensitivity control adjusts the system gain. A setting of 10 equals 100%, 5 equals 50%, etc.

Balance Meter and Control:

The center scale meter indicates the balance condition of conductivity within the fish tunnel. Normally the meter sets in the center, but when fish are in the tunnel the meter deflects left or right depending on which end of the tunnel the fish are in. The Balance Control (below the meter and behind the front panel) is used to compensate for slight differences between counting tunnels.

Upstream & Downstream Registers:

These registers indicate the total number of completed upstream and downstream fish passages through the counting tunnel.

Plugs and Connectors:

Data Output Plug - Provides logic output pulses as fish pass through the tunnel.

Tunnel Plug - Provides all signals to and from the counting tunnel.

AC plug - Provides power to run the counter and to charge the battery.

AC Power Indicator - Shows when AC power is applied.

Model 903-D, Cont.

Alignment Procedure

1. Submerge the counting tunnel in water making sure that the tunnel is completely filled with water. Connect the counting tunnel plug to the 903-D Fish Counter.
2. Turn the Power Switch ON.
3. If any counts are present on the LCD displays, press the Count Reset .
4. Preset the "Sensitivity" control to 50% or 5 on the scale. The "Balance" meter should be reading near zero (Note: the tunnel must be completely full of water with no air bubbles, debris, or fish in it during this step). If the meter does not indicate zero, remove the front panel plug below the word BALANCE and with a small screwdriver, carefully adjust the control inside until the meter reads zero. Increase the "Sensitivity" to 100% and readjust the balance control, if necessary. Replace the panel plug.
5. Starting at the lowest setting, adjust the Sensitivity Control clockwise until the 903-D counts the smallest fish expected, then turn the knob one division more. Count accuracy can be checked by hand counting the fish in each direction.

NOTE: The water flow through the tunnel can have a dramatic affect on accuracy of the fish counter. The hydraulics must be such that the fish will not lie resting in the tunnel. Air bubbles and debris passing through the tunnel must be kept to a minimum if accurate counts are to be obtained.

Cable runs between the fish counter tunnel/s and the 903-D longer than 50 feet should be run through metal conduit, especially if the counting system is located at a power dam or under high tension power lines.

Specifications:

Count rate.....	20 counts per second
Count Capacity per Channel.....	999,999(6 digit)
Count Sensitivity (Maximum).....	1% Tunnel Unbalance
Data Output	Positive logic: 1= +12 volts
Power Requirements.....	120VAC,60 Hz or 12 Volt Battery
Battery Life(internal battery).....	30 days Approx.
Size	13 7/8"L. X 6 3/8" W. X 7 1/2" H
Weight.....	8 1/2 pounds

FISH TUBE

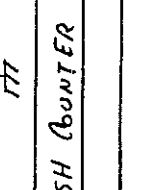
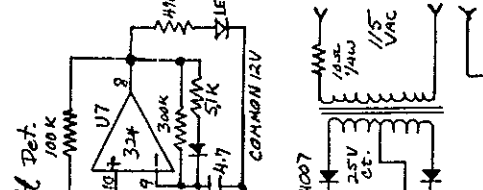
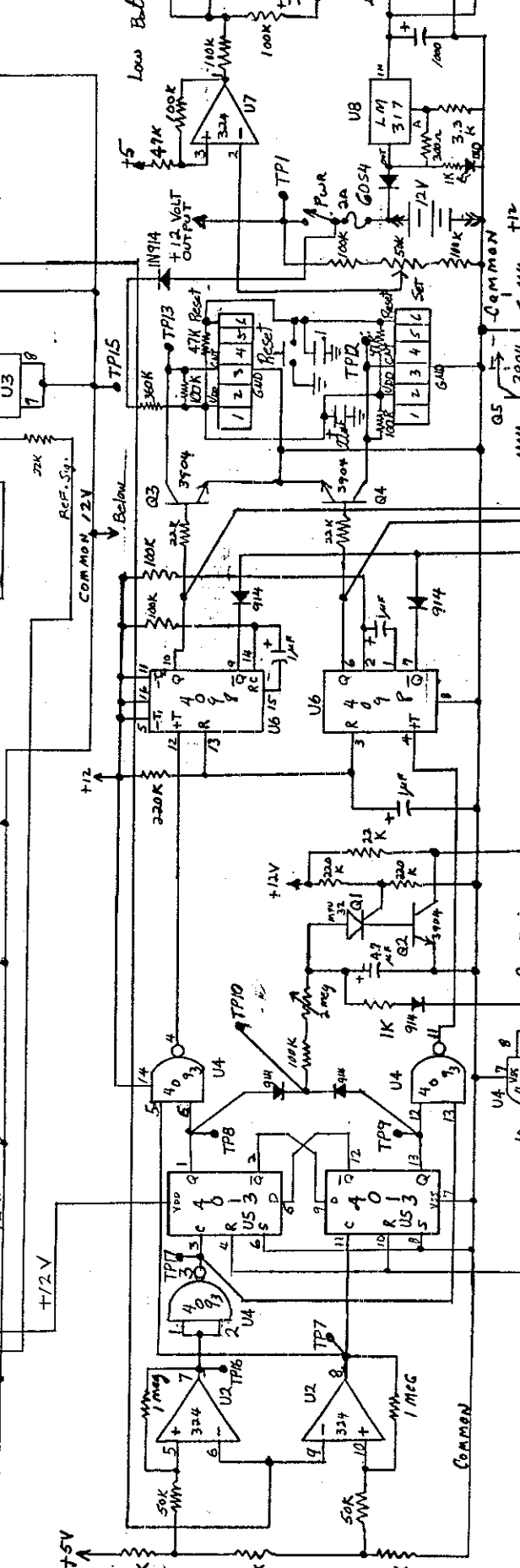
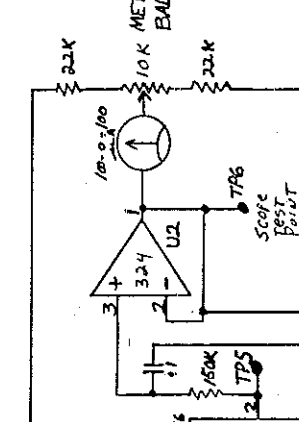
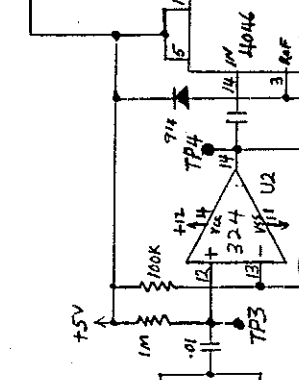
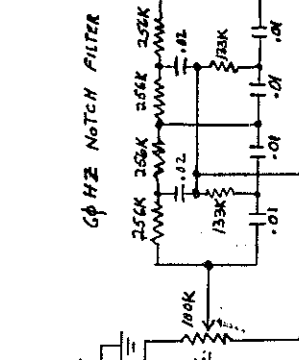
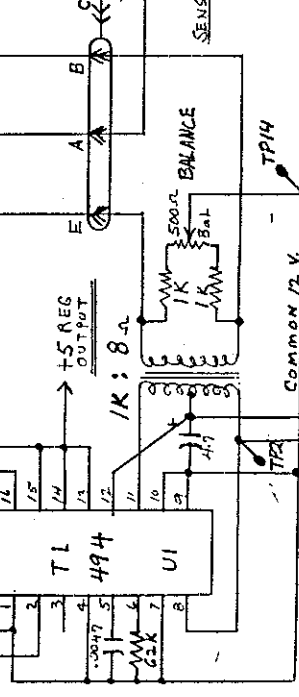

903-D FISH COUNTER
Date 7-84
REVA 1-85

EXT PLUG